

HB80-1C

Remote control rolling code 433.92 MHz, 1 channel.
Designed to control RGB and RGBW lights.

NEXTA
T E C H



1 - PRODUCT FEATURES

1.1 TECHNICAL DATA

Power supply	Type CR2450 lithium battery
Programmable channels	1
Groups	0
Radio frequency	433,92 MHz ISM
Code	Rolling code
Dimensions	Diameter 80X13

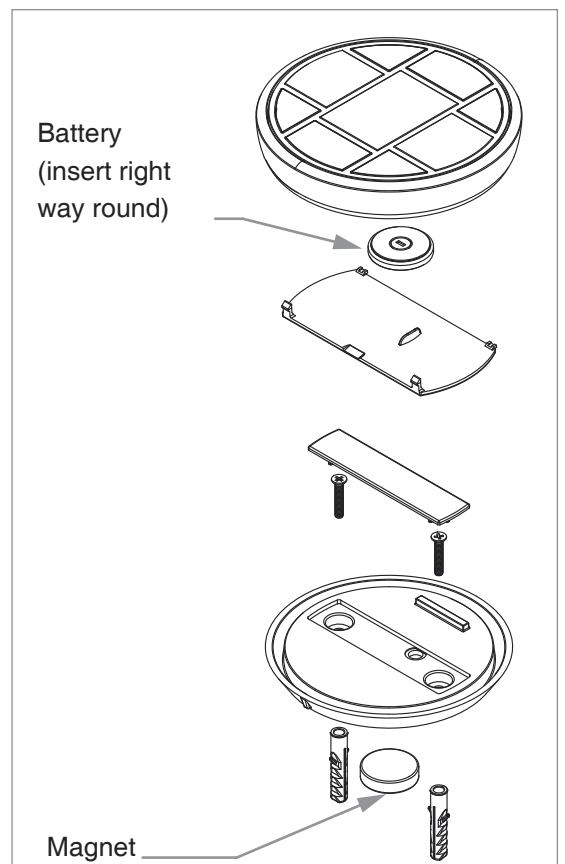
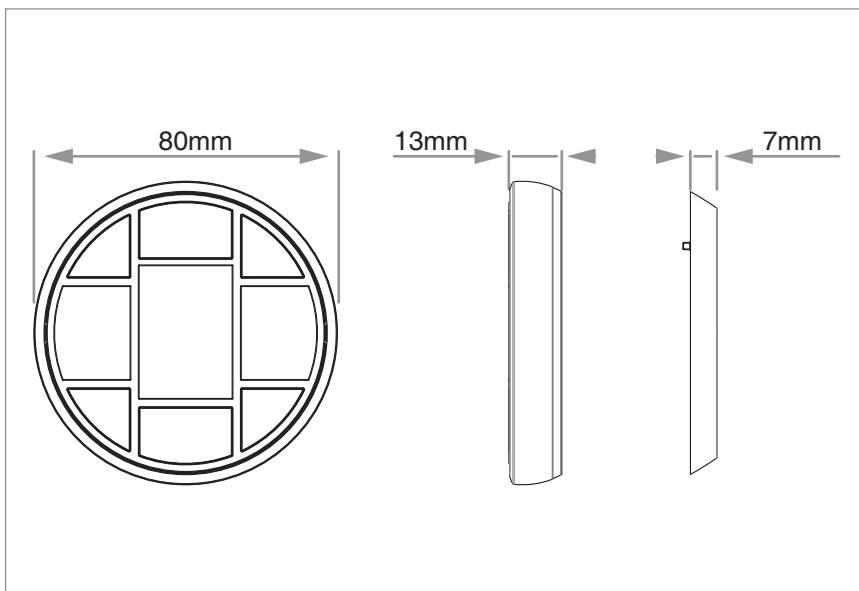

2 - USE OF TRANSMITTER

2.1 DESCRIPTION OF TRANSMITTER

Remote control rolling code 433.92 MHz, 4 channels and 1 group.

Designed to control RGB, RGBW, tunable white lights, dimmer and ON/OFF device.

The functions of each key depending on the type of lamp controlled are given below.

FIG.2.1a COMMANDS SENT ON A CONTROL UNIT FOR COLOURED LIGHTS

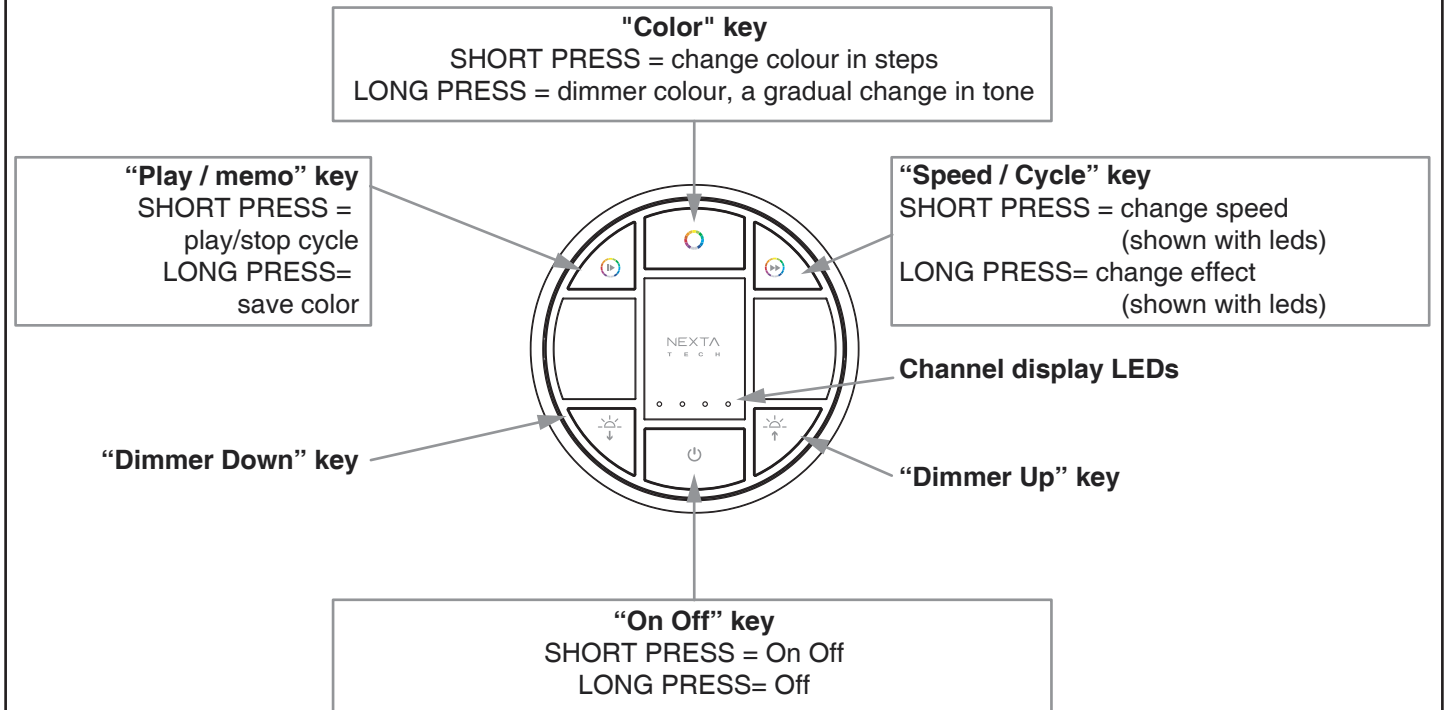

DESCRIPTION OF OPERATION OF KEYS

"Play / memo" key

SHORT PRESS: play/stop cycle.
Play is signalled by the load flashing, stop by the load flashing twice.

LONG PRESS: saves the colour/intensity the load is set with at that time.

"Speed / Cycle" key

SHORT PRESS: change speed of cycle:

SIGNAL	DURATION OF CYCLE
<i>Flash of led 1</i>	10 seconds
<i>Flash of led 2</i>	90 seconds
<i>Flash of led 3</i>	15 minutes
<i>Flash of led 4</i>	1 hour

LONG PRESS: change cycle effect:

SIGNAL	EFFECT OF CYCLE
<i>Flash of led 1</i>	the colour cycle passes through all the tones
<i>Flash of led 2</i>	the colour cycle passes through all the tones
<i>Flash of led 3</i>	colour cycle with blue and violet tones
<i>Flash of led 4</i>	colour cycle with red and orange tones

FIG.2.1b COMMANDS SENT ON A CONTROL UNIT FOR TUNABLE WHITE

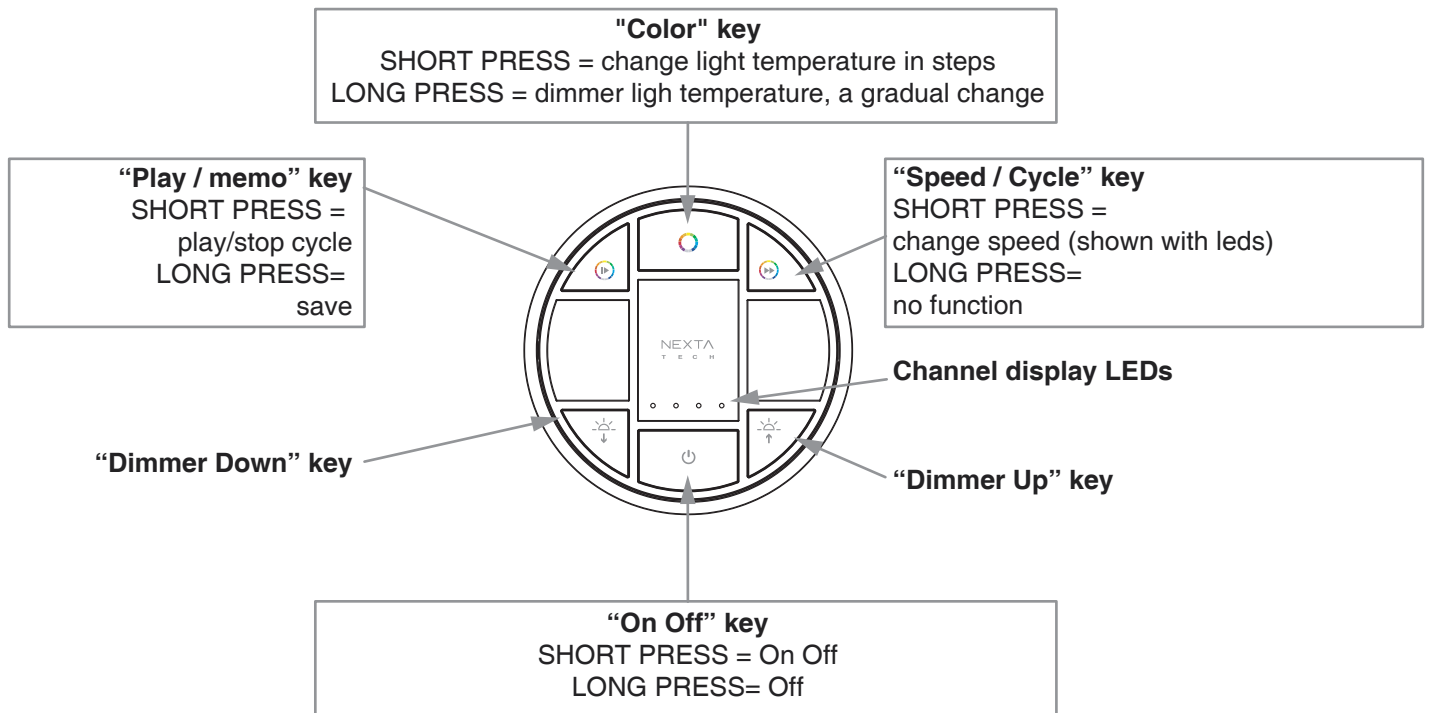

DESCRIPTION OF OPERATION OF KEYS

"Play / memo" key

SHORT PRESS: play/stop cycle.
Play is signalled by the load flashing, stop by the load flashing twice.
LONG PRESS: saves the colour/intensity the load is set with at that time.

"Speed / Cycle" key

SHORT PRESS: change speed of cycle:

SIGNAL	DURATION OF CYCLE
<i>Flash of led 1</i>	10 seconds
<i>Flash of led 2</i>	90 seconds
<i>Flash of led 3</i>	15 minutes
<i>Flash of led 4</i>	1 hour

2.2 USE OF TRANSMITTER

To be able to use the transmitter you must first carry out the learning procedures on the receiver (see paragraph 3).

SEND A COMMAND TO A DEVICE:

- 1- With the "channel" keys, select on the LEDs the channel associated with the device that you want to use.
- 2- Send the desired command with the "function" keys (see paragraph 2.3).
- 3- The transmitter remains in stand-by for 3 seconds and then switches off.

SEND A COMMAND TO A GROUP OF DEVICE:

- 1- Press the "All" key to select all 4 channels (the 4 LEDs switch on).
- 2- Send the desired command with the "function" keys (see paragraph 2.3).
- 3- The transmitter remains in stand-by for 3 seconds and then switches off.

3 - TRANSMITTER PROGRAMMING

To use the transmitter at least one channel must be programmed (paragraph 3.1).

3.1 TRANSMITTER PROGRAMMING

Default: no channel programmed

This procedure is used to programme a channel in order to then associate it with a compatible receiver. Access to the receiver is required to carry out the following procedure.

PROCEDURE:

- 1- Activate the receiver on which you want to programme the transmitter in "multifunctional remote control radio programming" mode (see receiver manual).
- 2- With the transmitter in stand-by (transmitter off), use the "channel" key to select the channel that you want to associate with the receiver and use the "function" key to send a transmission.
- 3- The receiver flashes 3 times to confirm the learning procedure (see receiver manual).
- 4- The transmitter goes back into stand-by.

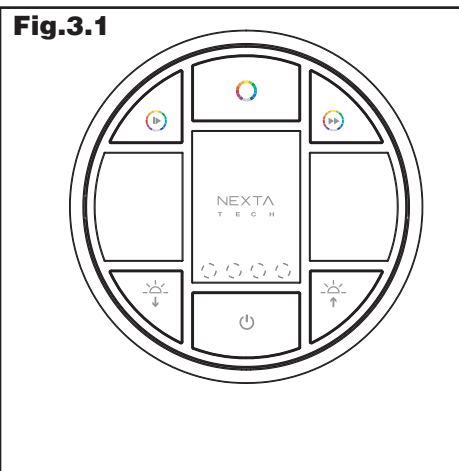

3.2 "REMOTE" ACTIVATION OF RECEIVER PROGRAMMING

Once the transmitter has been programmed following the procedure in paragraph 3.1, this transmitter can be used for remote activation of receiver programming and therefore to add further remote controls without accessing the receiver.

PROCEDURE:

- 1- Take up position near to the receiver.
- 2- With the transmitter already programmed, choose the channel associated with the receiver and press the "Play/stop cycle key" and "dimmer down key" at the same time for 3 seconds (the transmitter will start to flash). The receiver that the transmitter channel has been programmed on is activated for 30 seconds
- 3- Send a command with the new transmitter that you want to programme (see transmitter manual for use).

WARNING: Once the signal has been received from the new transmitter, the control unit will go back to normal operation; if you want to programme other transmitters repeat the procedure.

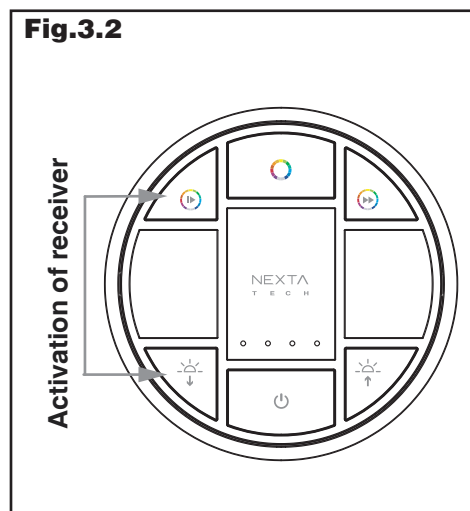

4 - DELETION OF A CHANNEL RECEIVER

4.1 DELETION OF THE CHANNEL FROM THE RECEIVER

This procedure is to delete one of the transmitter's channels from the memory of the receiver on which it was programmed.

PROCEDURE:

1- Access the receiver and carry out the "delete single transmitter" procedure (see receiver manual).



MNLHB80-1CENV1.0

Nexta Tech

company brand of Team srl
via G.Oberdan 90, 33074
Fontanafredda (PN) - Italy
Ph. +39 0434 998682
Email: info@nexta-tech.com
Web: www.nexta-tech.com